

# XR570C

## with built-in RS485

### CONTENTS

1. General Warning	1
2. General description	1
3. Controlling loads	1
4. Front panel commands	1
5. Clock functions	2
6. list of Parameters	2
7. digital inputs	3
8. Installation and mounting	3
9. Electrical connections	3
10. RS485 Serial communication	3
11. Use of the programming "HOT KEY "	3
12. Alarm signals	3
13. technical data	3
14. Connections	4
15. default setting values	4

### 1. GENERAL WARNING

#### 1.1 PLEASE READ BEFORE USING THIS MANUAL

- This manual is part of the product and should be kept near the instrument for easy and quick reference.
- The instrument shall not be used for purposes different from those described hereunder. It cannot be used as a safety device.
- Check the application limits before proceeding.

#### 1.2 SAFETY PRECAUTIONS

- Check the supply voltage is correct before connecting the instrument.
- Do not expose to water or moisture: use the controller only within the operating limits avoiding sudden temperature changes with high atmospheric humidity to prevent formation of condensation
- Warning: disconnect all electrical connections before any kind of maintenance.
- Fit the probe where it is not accessible by the End User. The instrument must not be opened.
- In case of failure or faulty operation send the instrument back to the distributor or to "Dixell s.r.l." (see address) with a detailed description of the fault.
- Consider the maximum current which can be applied to each relay (see Technical Data).
- Ensure that the wires for probes, leads and the power supply are separated and far enough from each other, without crossing or intertwining.
- In case of applications in industrial environments, the use of mains filters (our mod. FT1) in parallel with inductive loads could be useful.

### 2. GENERAL DESCRIPTION

All the models of this series are connectable to the XJ500 monitoring system through the two terminals of serial port RS485.

Model XR570C, 32x74 mm format, is a microprocessor based controllers suitable for applications on medium or low temperature refrigerating units. It's provided with three relay outputs to control compressor, defrost - which can be either electrical or hot gas -, the evaporator fans and alarm or auxiliary output. It's also provided with two PTC or NTC probe inputs configurable by the User, one for temperature control, the other to control the defrost end temperature of the evaporator, two digital inputs (free contact) are configurable by parameter and an internal buzzer for acoustic signal. Each instrument is fully configurable through special parameters that can be easily programmed through the keypad.

### 3. CONTROLLING LOADS

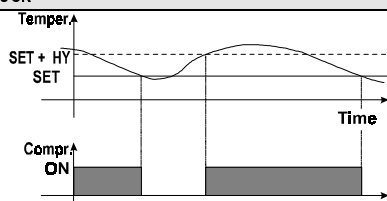

#### 3.1 THE COMPRESSOR



The regulation is performed according to the temperature measured by the thermostat probe with a positive differential from the set point: if the temperature increases and reaches set point plus differential the compressor is started and then turned off when the temperature reaches the set point value again.

In case of fault in the thermostat probe the start and stop of the compressor are timed through parameters "CO<sub>n</sub>" and "CO<sub>F</sub>".

#### 3.2 FAST FREEZING

When defrost is not in progress, it can be activated the keypad by holding the  key pressed for about 3 seconds. The compressor operates in continuous mode for the time set through the "CC<sub>T</sub>" parameter. The cycle can be terminated before the end of the set time using the same activation key,  for about 3 seconds.

#### 3.3 DEFROST

Three defrost modes are available through the "td<sub>F</sub>" parameter: defrost with electrical heater, hot gas or thermostatic defrost. The defrost interval is control by means of parameter "Ed<sub>F</sub>" (Ed<sub>F</sub> = in) the defrost is made every "ld<sub>F</sub>" time, (Ed<sub>F</sub> = Sd) the interval "ld<sub>F</sub>" is calculate through Smart Defrost algorithm (only when the compressor is ON and the evaporator temperature is bigger than "Sd<sub>F</sub>" parameter).

At the end of defrost the drip time is controlled through the "Fd<sub>t</sub>" parameter.

#### 3.4 CONTROL OF EVAPORATOR FANS

The fan control mode is selected by means of the "Fn<sub>C</sub>" parameter:

- Fn<sub>C</sub> = C-n fans will switch ON and OFF with the compressor and not run during defrost;
- Fn<sub>C</sub> = C-y fans will run continuously, but not during defrost
- Fn<sub>C</sub> = O-n fans will switch ON and OFF with the compressor and run during defrost;
- Fn<sub>C</sub> = O-y fans will run continuously also during defrost

After defrost, there is a timed fan delay allowing for drip time, set by means of the "Fn<sub>d</sub>" parameter.

An additional parameter "FS<sub>t</sub>" provides the setting of temperature, detected by the evaporator probe, above which the fans are always OFF. This can be used to make sure circulation of air only if his temperature is lower than set in "FS<sub>t</sub>".

### 4. FRONT PANEL COMMANDS



#### SET



To display target set point; in programming mode it selects a parameter or confirm an operation.

By holding it pressed for 5s the instrument Stand By starts (if it is enable)

By holding it pressed for 3s when max or min temperature is displayed it will be erased.

To start a manual defrost

To see the max. stored temperature; in programming mode it browses the parameter codes or increases the displayed value. By holding it pressed for 3s the fast freezing cycle is started

To see the min stored temperature; in programming mode it browses the parameter codes or decreases the displayed value. By holding it pressed for 3s the auxiliary relay is switched ON or OFF (If it is configured)

#### KEY COMBINATIONS:



To lock & unlock the keyboard.













To enter in programming mode.



To return to the room temperature display.



#### 4.1 USE OF LEDES

Each LED function is described in the following table.

LED	MODE	Function
	ON	Compressor enabled
	FLASHING	- Programming Phase (flashing with LED  - Anti-short cycle delay enabled
	ON	Fan enabled
	FLASHING	Programming Phase (flashing with LED  )
	ON	Defrost enabled
	FLASHING	Drip time in progress
	ON	Fast freezing enabled
	ON	- ALARM signal - In "Pr1" indicates the parameter is also present in "Pr1"
AUX	ON	Auxiliary relay is ON



#### 4.2 HOW TO SEE THE MIN TEMPERATURE



- Press and release the  key.
- The "Lo" message will be displayed followed by the minimum temperature recorded.
- By pressing the  key or waiting for 5s the normal display will be restored.

#### 4.3 HOW TO SEE THE MAX TEMPERATURE



- Press and release the  key.
- The "Hi" message will be displayed followed by the maximum temperature recorded.
- By pressing the  key or waiting for 5s the normal display will be restored.

#### 4.4 HOW TO RESET THE MAX AND MIN TEMPERATURE RECORDED

To reset the stored temperature, when max or min temperature is displayed :

- Press SET key until "rST" label starts blinking.





#### 4.5 HOW TO SEE THE SET POINT



- Push and immediately release the SET key: the display will show the Set point value;
- Push and immediately release the SET key or wait for 5seconds to display the probe value again.

#### 4.6 HOW TO CHANGE THE SETPOINT



- Push the SET key for 3 seconds to change the Set point value;
- The value of the set point will be displayed and the  and  LEDs start blinking;
- To change the Set value push the  or  arrows within 10s.
- To memorise the new set point value push the SET key again or wait 10s.

#### 4.7 HOW TO START A MANUAL DEFROST





- Push the DEF key for more than 2 seconds and a manual defrost will start.

#### 4.8 TO ENTER IN PARAMETERS LIST "PR1"



To enter the parameter list "Pr1" (user accessible parameters) operate as follows:

- Enter the Programming mode by pressing the Set and UP key for few seconds ( and  start blinking).
- The instrument will show the first parameter present in "Pr1"

**4.9 TO ENTER IN PARAMETERS LIST "Pr2"**

To enter in the parameter list "Pr2" (installer level) operate as follows:



To access parameters in "Pr2" a security code is required.

1. To enter in "Pr1" level.
2. Select "Pr2" parameter and press the "SET" key.
3. The "PAS" flashing message is displayed, shortly followed by "0-" with a flashing zero.
4. Use  $\Delta$  or  $\nabla$  to input the security code in the flashing digit; confirm the figure by pressing "SET". The security code is "321".
5. If the security code is correct the access to "Pr2" is enabled by pressing "SET" on the last digit.

**NOTE:** each parameter in "Pr2" can be removed or put into "Pr1" (user level) by pressing "SET" +  $\nabla$ . When a parameter is present in "Pr1" LED (i) is on.

**4.10 HOW TO CHANGE THE PARAMETER VALUE**

To change the parameter's value operate as follows:



1. Enter the Programming mode.
  2. Select the required parameter with  $\Delta$  or  $\nabla$ .
  3. Press the "SET" key to display its value and LED starts blinking.
  4. Use  $\Delta$  or  $\nabla$  to change its value.
  5. Press "SET" to store the new value and move to the following parameter.
- To exit: Press SET + UP or wait 15s without pressing a key.
- NOTE:** the new programming is stored even when the procedure is exited by waiting the time-out.

**4.11 HOW TO LOCK THE KEYBOARD**

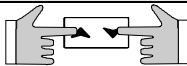

1. Keep pressed for more than 3 s the  $\Delta$  and  $\nabla$  keys.
2. The "POF" message will be displayed and the keyboard is locked. At this point it is only possible the viewing of the set point or the MAX or Min temperature stored.

**4.11.1 TO UNLOCK THE KEYBOARD**

Keep pressed together for more than 3s the  $\Delta$  and  $\nabla$  keys.

**4.12 STAND BY FUNCTION**

If the stand-by function is enabled (Onf = 1), by holding pressed the SET key for 5s., the instrument shows "OFF". The stand-by function switches OFF all the relays and stops the regulation. During the stand by if a XJ500 is connected, it does not record the instrument data and alarms.

**N.B. When the instrument is under Stand-by, all the relays are under power supply. Don't connect any loads to the normal closed contact of the relays.**

**5. CLOCK FUNCTIONS**

**5.1 TO DISPLAY CURRENT HOUR AND DATE**

1. Enter parameter list "Pr1" (press SET +  $\nabla$  for some seconds)
2. The controller displays the parameter rTc
3. Press SET key, the controller displays the following labels  
 Hur (hour) and the current hour  
 Min (Minute) and the current minutes  
 dAY (day) and the current day. Mon (Monday), Tue (Tuesday), Wed (Wednesday), Thu (Thursday), Fri (Friday), Sat (Saturday), Sun (Sunday)
4. Press  $\nabla$  key or wait for 5 seconds to go back to normal temperature display.

**5.2 TO PROGRAM HOUR, DATE AND HOLYDAY**

1. Enter parameter list "Pr1" (press SET +  $\nabla$  for some seconds)
2. The controller displays the parameter rTc
3. Press SET key, the controller displays hour and date.
4. By pressing SET it will be possible to program the current hour, date and the 3 week end days
5. Press  $\nabla$  key or wait for 5 seconds to go back to normal temperature display.

**6. LIST OF PARAMETERS**

- Hy** Differential: (0,2°C  $\pm$  30,0°C / 1°F  $\pm$  54°F): Intervention differential for set point, always positive. Compressor Cut IN is Set Point Plus Differential (Hy). Compressor Cut OUT is when the temperature reaches the set point.
- LS** Minimum set point limit: (-50,0°C  $\pm$  SET / -58°F  $\pm$  SET) Sets the minimum acceptable value for the set point.
- US** Maximum set point limit: (SET + 150°C / SET + 302°F) Set the maximum acceptable value for set point.
- OdS** Outputs activation delay at start up: (0  $\pm$  255 min) This function is enabled at the initial start up of the instrument and inhibits any output activation for the period of time set in the parameter. (AUX and Light can work)
- AC** Anti-short cycle delay: (0  $\pm$  30 min) interval between the compressor stop and the following restart.
- Cct** Thermostat override: (0min  $\pm$  23h 50min) allows to set the length of the continuous cycle. Can be used, for instance, when the room is filled with new products.
- Con** Compressor ON time with faulty probe: (0  $\pm$  255 min) time during which the compressor is active in case of faulty thermostat probe. With CO n=0 compressor is always OFF.
- COF** Compressor OFF time with faulty probe: (0  $\pm$  255 min) time during which the compressor is off in case of faulty thermostat probe. With COF=0 compressor is always active.

**DISPLAY**

- CF** Temperature measurement unit: °C = Celsius; °F = Fahrenheit. When the measurement unit is changed the SET point and the values of the regulation parameters have to be modified
- rES** Resolution (for °C): (in = 1°C; de = 0,1°C) allows decimal point display.  
 de = 0,1°C  
 in = 1°C
- Lod** Local display: select which probe is displayed by the instrument:  
 P1 = Thermostat probe  
 P2 = Evaporator probe  
 P3 = auxiliary probe  
 1r2 = difference between P1 and P2 (P1-P2)
- Red** Remote display: select which probe is displayed by the remote display (XW-REP)  
 P1 = Thermostat probe  
 P2 = Evaporator probe  
 P3 = auxiliary probe  
 1r2 = difference between P1 and P2 (P1-P2)

**DEFROST**

- tdF** Defrost type:  
 rE = electrical heater (Compressor OFF)  
 rT = thermostat defrost. During the defrost time "MdF", the heater switches On and OFF depending on the evaporator temperature and "dIE" value.  
 in = hot gas (Compressor and defrost relays ON)
- EdF** Defrost mode:  
 in = interval mode. The defrost starts when the time "ldF" is expired.  
 Sd = Smart Defrost mode. The time ldF (interval between defrosts) is increased only when the compressor is running (even non consecutively) and only if the evaporator temperature is less than the value in "SdF" (set point for SMARTFROST).
- SdF** Set point for SMARTFROST: (-30  $\pm$  30 °C / -22  $\pm$  86 °F) evaporator temperature which allows the ldF counting (interval between defrosts) in SMARTFROST mode.
- dTE** Defrost termination temperature: (-50,0  $\pm$  110,0°C; -58  $\pm$  230°F) (Enabled only when the evaporator probe is present) sets the temperature measured by the evaporator probe which causes the end of defrost.
- ldF** Interval between defrosts: (1  $\pm$  120h) Determines the time interval between the beginning of two defrost cycles.
- MdF** (Maximum) duration of defrost: (0  $\pm$  255 min) When P2P = n, no evaporator probe, it sets the defrost duration, when P2P = y, defrost end based on temperature, it sets the maximum length for defrost.
- dFd** Display during defrost:  
 rt = real temperature;  
 it = temperature reading at the defrost start;  
 Set = set point;  
 dEF = "dEF" label;  
 dEG = "dEG" label;
- dAd** Defrost display time out: (0  $\pm$  255 min) Sets the maximum time between the end of defrost and the restarting of the real room temperature display.
- Fdt** Drain down time: (0  $\pm$  60 min.) time interval between reaching defrost termination temperature and the restoring of the control's normal operation. This time allows the evaporator to eliminate water drops that might have formed due to defrost.
- dPO** First defrost after start-up:  
 y = Immediately;  
 n = after the ldF time
- dAF** Defrost delay after fast freezing: (0min  $\pm$  23h 50min) after a Fast Freezing cycle, the first defrost will be delayed for this time.

**FANS**

- FnC** Fan operating mode:  
 C-n = running with the compressor, OFF during the defrost;  
 C-y = running with the compressor, ON during the defrost;  
 O-n = continuous mode, OFF during the defrost;  
 O-y = continuous mode, ON during the defrost;
- Fnd** Fan delay after defrost: (0  $\pm$  255 min) The time interval between the defrost end and evaporator fans start.
- FSt** Fan stop temperature: (-50  $\pm$  110°C; -58  $\pm$  230°F) setting of temperature, detected by evaporator probe, above which the fan is always OFF.

**ALARMS**

- ALC** Temperature alarm configuration  
 rE = High and Low alarms related to Set Point  
 Ab = High and low alarms related to the absolute temperature.
- ALU** High temperature alarm setting:  
 ALC = rE, 0  $\pm$  50°C or 90°F  
 ALC = Ab, ALL  $\pm$  110°C or 230°F  
 when this temperature is reached and after the ALd delay time the HA alarm is enabled.
- ALL** Low temperature alarm setting:  
 ALC = rE, 0  $\pm$  50°C or 90°F  
 ALC = Ab, -50°C or -58°F  $\pm$  ALU  
 when this temperature is reached and after the ALd delay time, the LA alarm is enabled.
- AFH** Temperature alarm and fan differential: (0,1  $\pm$  25,5°C; 1  $\pm$  45°F) Intervention differential for temperature alarm set point and fan regulation set point, always positive.
- ALd** Temperature alarm delay: (0  $\pm$  255 min) time interval between the detection of an alarm condition and the corresponding alarm signalling.
- dAO** Delay of temperature alarm at start-up: (0min  $\pm$  23h 50min) time interval between the detection of the temperature alarm condition after the instrument power on and the alarm signalling.
- EdA** Alarm delay at the end of defrost: (0  $\pm$  255 min) Time interval between the detection of the temperature alarm condition at the end of defrost and the alarm signalling.
- dot** Delay of temperature alarm after closing the door: (0  $\pm$  255 min) Time delay to signal the temperature alarm condition after closing the door.
- doA** Open door alarm delay: (0  $\pm$  255 min) delay between the detection of the open door condition and its alarm signalling: the flashing message "dA" is displayed.
- tbA** Buzzer and alarm relay silencing: by pushing one of the keypad buttons.  
 n = Only the Buzzer is silenced;  
 y = Buzzer and relay are silenced.
- nPS** Pressure switch number: (0  $\pm$  15) Number of activation of the pressure switch, during the "did" interval, before signalling the alarm event (1r2 = PAL).

**ANALOGUE OUTPUT 4  $\pm$  20 mA (OPTIONAL)**

- AOS** Analogue output start point: (-50  $\pm$  110°C or -58  $\pm$  230°F). Sets the temperature at which the analogue output begins.
- APb** Analogue output band width: (-50  $\pm$  110°C or -58  $\pm$  230°F) sets the width of the regulation band for the analogue output. If APb is positive then it is above the start point and the kind of action is direct (condenser application). If APb is negative then it is below the start point and the kind of action is inverse (evaporator application).
- CAO** Input type for the analogue output: four input types can be selected:  
 P1 = room probe temperature; P2 = evaporator probe temperature; P3 = temperature of the third probe  
 1r2= temperature difference between the room probe and the evaporator probe

**PROBE INPUTS**

- Ot** Thermostat probe calibration: (-12,0  $\pm$  12,0°C / -21  $\pm$  21°F) allows to adjust possible offset of the thermostat probe.
- OE** Evaporator probe calibration: (-12,0  $\pm$  12,0°C / -21  $\pm$  21°F) allows to adjust possible offsets of the evaporator probe.
- O3** Auxiliary probe calibration: (-12,0  $\pm$  12,0°C / -21  $\pm$  21°F) allows to adjust possible offsets of the evaporator probe.
- P2P** Evaporator probe presence:  
 n = not present: the defrost stops only by time; y = present: the defrost stops by temperature and time.
- P3P** Auxiliary probe presence: n = not present; y = present.
- Pbr** Regulation probe selection:  
 P1 = Thermostat probe  
 P2 = Evaporator probe  
 P3 = Auxiliary probe  
 1r2= P1-P2
- HES** Temperature increase during the Energy Saving cycle: (-30,0°C  $\pm$  30,0°C / -22  $\pm$  86°F) sets the increasing value of the set point during the Energy Saving cycle.

**DIGITAL INPUTS**

- odc** Compressor and fan status when open door:  
 no = normal;  
 Fan = Fan OFF;  
 CPr = Compressor OFF;  
 F\_C = Compressor and fan OFF.

- I1P Door switch input polarity:**  
**CL** : the digital input is activated by closing the contact;  
**OP** : the digital input is activated by opening the contact.
- I2P Configurable digital input polarity:**  
**CL** : the digital input is activated by closing the contact;  
**OP** : the digital input is activated by opening the contact
- I2F Digital input operating mode:** configure the digital input function:  
**EAL** = generic alarm;  
**bAL** = serious alarm mode;  
**PAL** = Pressure switch;  
**dFr** = Start defrost;  
**AUS** = Relay AUX actuation;  
**Es** = Energy Saving;  
**onF** = remote On/OFF.

**did Time interval/delay for digital input alarm:**(0÷255 min.) Time interval to calculate the number of the pressure switch activation when I2F=PAL. If I2F=EAL or bAL (external alarms), "did" parameter defines the time delay between the detection and the successive signalling of the alarm.

#### TO SET CURRENT TIME AND WEEKLY HOLIDAYS

**Hur** Current hour (0 + 23 h)  
**Min** Current minute (0 + 59min)  
**dAY** Current day (Sun + SA1)  
**Hd1** First weekly holiday (Sun + nu) Set the first day of the week which follows the holiday times.  
**Hd2** Second weekly holiday (Sun + nu) Set the second day of the week which follows the holiday times.  
**Hd3** Third weekly holiday (Sun + nu) Set the third day of the week which follows the holiday times.

**N.B.** Hd1,Hd2,Hd3 can be set also as "nu" value (Not Used).

#### TO SET ENERGY SAVING TIMES

**IE** Energy Saving cycle start during workdays: (0 + 23h 50 min.) During the Energy Saving cycle the set point is increased by the value in HES so that the operation set point is SET + HES.  
**dLE** Energy Saving cycle length during workdays: (0 + 24h 00 min.) Sets the duration of the Energy Saving cycle on workdays.  
**ISE** Energy Saving cycle start on holidays: (0 + 23h 50 min.)  
**dSE** Energy Saving cycle length on holidays (0 + 24h 00 min.)  
**HES** Temperature increase during the Energy Saving cycle (-30÷30°C / -54÷+54°F) sets the increasing value of the set point during the Energy Saving cycle.

#### TO SET DEFROST TIMES

**Ld1÷Ld8 Workday defrost start** (0 + 23h 50 min.) These parameters set the beginning of the eight programmable defrost cycles during workdays. Ex. When Ld2 = 1.24 the second defrost starts at 12.40 during workdays.  
**Sd1÷Sd8 Holiday defrost start** (0 + 23h 50 min.) These parameters set the beginning of the eight programmable defrost cycles on holidays. Ex. When Sd2 = 3.4 the second defrost starts at 3.40 on holidays..

**N.B. :** To disable a defrost cycle set it to "nu" (not used).  
 Ex. If Ld6=nu ; the sixth defrost cycle is disabled

#### OTHER

**oA3 Auxiliary relay configuration:**  
**ALr** = Alarm Relay  
**AuS** = Auxiliary relay

**Adr RS485 serial address** (1÷247): Identifies the instrument address when connected to a ModBUS compatible monitoring system.

**PbC Probe type selection:** (NTC or PTC) select the type of probe used

**onF Stand-by function:**  
**0** = Stand-by function not enabled.  
**1** = Stand-by function enabled (under SET key control).

**Rel Release software:** (read only) Software version of the microprocessor.

**Ptb Parameter table:** (read only) it shows the original code of the **dixell** parameter map.

**Prd Probes display:** (read only) display the temperature values of the evaporator probe Pb2 and the auxiliary probe Pb3.

**Pr2 Access to the protected parameter list** (read only).

### 7. DIGITAL INPUTS

XR570C can support up to 2 free contact digital inputs. One is always configured as door switch, the second is programmable in seven different configurations by the "I2F" parameter.

#### 7.1 DOOR SWITCH INPUT

It signals the door status and the corresponding relay output status through the "odc" parameter:

**no** = normal (any change);  
**Fan** = Fan OFF;  
**CPr** = Compressor OFF;  
**F\_C** = Compressor and fan OFF.

Since the door is opened, after the delay time set through parameter "dOA", the alarm output is enabled and the display shows the message "dA". The alarm stops as soon as the external digital input is disabled again. During this time and then for the delay "dot" after closing the door, the high and low temperature alarms are disabled.

#### 7.2 CONFIGURABLE INPUT - GENERIC ALARM (EAL)

As soon as the digital input is activated the unit will wait for "did" time delay before signalling the "EAL" alarm message. The outputs status don't change. The alarm stops just after the digital input is de-activated.

#### 7.3 CONFIGURABLE INPUT - SERIOUS ALARM MODE (BAL)

When the digital input is activated, the unit will wait for "did" delay before signalling the "BAL" alarm message. The relay outputs are switched OFF. The alarm will stop as soon as the digital input is de-activated.

#### 7.4 CONFIGURABLE INPUT - PRESSURE SWITCH (PAL)

If during the interval time set by "did" parameter, the pressure switch has reached the number of activation of the "nPS" parameter, the "PAL" pressure alarm message will be displayed. The compressor and the regulation are stopped. When the digital input is ON the compressor is always OFF.

#### 7.5 CONFIGURABLE INPUT - START DEFROST (DFR)

It executes a defrost if there are the right conditions. After the defrost is finished, the normal regulation will restart only if the digital input is disabled otherwise the instrument will wait until the "Mdf" safety time is expired.

#### 7.6 CONFIGURABLE INPUT - RELAY AUX ACTUATION (AUS)

This function allows to turn ON and OFF the auxiliary relay by using the digital input as external switch. The function is enabled until the digital input is activate.

#### 7.7 CONFIGURABLE INPUT - ENERGY SAVING (ES)

The Energy Saving function allows to change the set point value as the result of the SET+HES (parameter) sum. This function is enabled until the digital input is activate.

#### 7.8 CONFIGURABLE INPUT - REMOTE ON/OFF (ONF)

This function allows to switch ON and OFF the instrument.

#### 7.9 DIGITAL INPUTS POLARITY

The digital inputs polarity depends on "I1P" and "I2P" parameters.

**CL** : the digital input is activated by closing the contact.  
**OP** : the digital input is activated by opening the contact

### 8. INSTALLATION AND MOUNTING

XR570C controller shall be mounted on panel, in a 29x71 mm hole, and fixed using the special bracket supplied. The temperature range allowed for correct operation is 0 - 60 °C. Avoid places subject to strong vibrations, corrosive gases, excessive dirt or humidity. The same recommendations apply to probes. Let air circulate by the cooling holes.

### 9. ELECTRICAL CONNECTIONS

The instruments are provided with screw terminal block to connect cables with a cross section up to 2,5 mm<sup>2</sup>. Before connecting cables make sure the power supply complies with the instruments requirements. Separate the probe cables from the power supply cables, from the outputs and the power connections. Do not exceed the maximum current allowed on each relay, in case of heavier loads use a suitable external relay.

#### 9.1 PROBE CONNECTION

The probes shall be mounted with the bulb upwards to prevent damages due to casual liquid infiltration. It is recommended to place the thermostat probe away from air streams to correctly measure the average room temperature. Place the defrost termination probe among the evaporator fins in the coldest place, where most ice is formed, far from heaters or from the warmest place during defrost, to prevent premature defrost termination.

### 10. RS485 SERIAL COMMUNICATION

The RS485 serial communication port allows to connect the unit, by means of a simple 2 wires shielded cable, to a network line ModBUS-RTU compatible as the **dixell** monitoring system XJ500 (Version 3.2).

### 11. USE OF THE PROGRAMMING "HOT KEY"

XR170C units can UPLOAD or DOWNLOAD the parameter list from its own E2 internal memory to the "Hot Key" and vice-versa.

#### 11.1 DOWNLOAD (FROM THE "HOT KEY" TO THE INSTRUMENT)

- Turn OFF the instrument by means of the ON/OFF key, remove the TTL serial cable if present, insert the "Hot Key" and then turn the Controller ON.
  - Automatically the parameter list of the "Hot Key" is downloaded into the Controller memory, the "DoL" message is blinking. After 10 seconds the instrument will restart working with the new parameters.
  - Turn OFF the instrument remove the "Hot Key", plug in the TTL serial cable, then turn it ON again.
- At the end of the data transfer phase the instrument displays the following messages:  
 "end" for right programming. The instrument starts regularly with the new programming.  
 "err" for failed programming. In this case turn the unit off and then on if you want to restart the download again or remove the "Hot key" to abort the operation.

#### 11.2 UPLOAD (FROM THE INSTRUMENT TO THE "HOT KEY")

- Turn OFF the instrument by means of the ON/OFF key and remove the TTL serial cable if present; then turn it ON again.
- When the Controller is ON, insert the "Hot key" and push  $\leftarrow$  key; the "uPL" message appears.
- Push "SET" key to start the UPLOAD; the "uPL" message is blinking.
- Turn OFF the instrument remove the "Hot Key", plug in the TTL serial cable, then turn it ON again.

At the end of the data transfer phase the instrument displays the following messages:

"end" for right programming.  
 "err" for failed programming. In this case push "SET" key if you want to restart the programming again or remove the not programmed "Hot key".

### 12. ALARM SIGNALS

Message	Cause	Outputs
"P1"	Thermostat probe failure	Alarm output ON; Compressor output according to parameters "COm" and "COF"
"P2"	Evaporator probe failure	Alarm output ON; Other outputs unchanged
"P3"	Auxiliary probe failure	Alarm output ON; Other outputs unchanged
"HA"	Maximum temperature alarm	Alarm output ON; Other outputs unchanged
"LA"	Minimum temperature alarm	Alarm output ON; Other outputs unchanged
"EE"	Data or memory failure	Alarm output ON; Other outputs unchanged
"dA"	Door switch alarm	Alarm output ON; Other outputs unchanged
"EAL"	External alarm	Alarm output ON; Other outputs unchanged
"BAL"	Serious external alarm	Alarm output ON; Other outputs OFF
"PAL"	Pressure switch alarm	Alarm output ON; Other outputs OFF

The alarm message is displayed until the alarm condition is recovery.

All the alarm messages are showed alternating with the room temperature except for the "P1" which is flashing.  
 To reset the "EE" alarm and restart the normal functioning press any key, the "rSt" message is displayed for about 3s.

#### 12.1 SILENCING BUZZER / ALARM RELAY OUTPUT

If "tbA = y", once the alarm signal is detected the buzzer and the relay are silenced by pressing any key.  
 If "tbA = n", only the buzzer is silenced while the alarm relay is on until the alarm condition recovers.

#### 12.2 "EE" ALARM

The **dixell** instruments are provided with an internal check for the data integrity. Alarm "EE" flashes when a failure in the memory data occurs. In such cases the alarm output is enabled.

#### 12.3 ALARM RECOVERY

Probe alarms : "P1" (probe faulty), "P2" and "P3"; they automatically stop 10s after the probe restarts normal operation. Check connections before replacing the probe.

Temperature alarms "HA" and "LA" automatically stop as soon as the thermostat temperature returns to normal values or when the defrost starts.

Door switch alarm "dA" stop as soon as the door is closed.

External alarms "EAL", "BAL" stop as soon as the external digital input is disabled "PAL" alarm is recovered by switching OFF the instrument.

### 13. TECHNICAL DATA

**Housing:** self extinguishing ABS.

**Case:** frontal 32x74 mm; depth 70mm

**Mounting:** panel mounting in a 71x29 mm panel cut-out.

**Frontal protection:** IP65

**Connections:** Screw terminal block  $\leq$  2,5 mm<sup>2</sup> wiring.

**Power supply:** 1.2V<sub>ac</sub>/dc (opt.24V<sub>ac</sub>/dc), -10% +15%.

**Power absorption:** 3VA max.

**Display:** 3 digits, red LED, 14,2 mm high.

**Inputs:** 3 PTC or NTC configurable.

**Relay outputs**

**compressor:** SPST relay 8(3)A, 250V<sub>ac</sub>

**defrost:** SPDT relay 8(3) A, 250V<sub>ac</sub>

**fans:** SPST 8(3)A, 250V<sub>ac</sub>

**alarm or auxiliary:** SPDT relay 8(3) A, 250V<sub>ac</sub>

**Other output:** buzzer for an acoustic signal of alarms

**Serial Output :** RS485 serial communication port with ModBUS-RTU protocol

**Data storing:** on the non-volatile memory (EEPROM).

**Kind of action:** 1B.

**Pollution grade:** normal

**Software class:** A.

**Operating temperature:** 0÷60 °C.

**Relative humidity:** 20÷85% (no condensing)

Storage temperature: -30+85 °C.

Measuring and regulation range:

PTC: -50+150°C (-58+302°F)

NTC: -50+110°C (-58+230°F)

Resolution: 0,1 °C or 1 °F (selectable).

Accuracy of the controller at 25°C: range -40+50°C (-40+122°F): ±0,3 °C ±1 digit

14. CONNECTIONS

14.1 XR570C

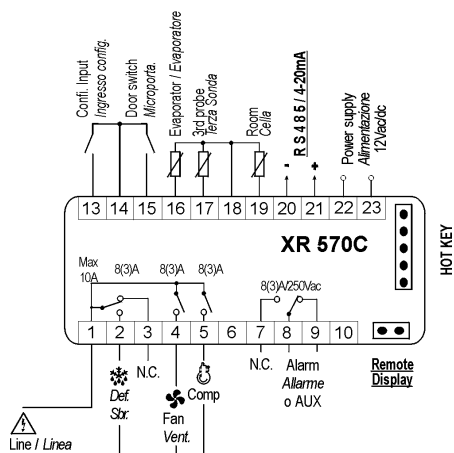

15. DEFAULT SETTING VALUES

Label	Name	Limits	Default	XR570C
<b>REGULATION</b>				
Set	Set point	LS+US	-5	Pr1
Hy	Differential	0,1+25,5 °C / 1+45°F	2	Pr1
LS	Minimum set point	-50,0°C+SET / -58°F+SET	-30	Pr2
US	Maximum set point	SET + 110°C / SET + 230°F	20	Pr2
OdS	Outputs activation delay at start up	0+255 min.	0	Pr2
AC	Anti-short cycle delay	0+30 min.	1	Pr1
CCt	Compressor ON time during fast freezing	0 + 23h 50 min.	0	Pr2
COt	Compressor ON time with faulty probe	0+255 min.	15	Pr2
COF	Compressor OFF time with faulty probe	0+255 min.	30	Pr2
<b>DISPLAY</b>				
CF	Temperature measurement unit	°C + °F	°C	Pr2
rES	Resolution (integer/decimal point)	in + de	De	Pr1
Lod	Local display	P1 + 1r2	P1	Pr2
Red	Remote display	P1 + 1r2	P1	Pr2
<b>DEFROST</b>				
tdF	Defrost type	rE, rT, in	rE	Pr1
EdF	Defrost mode	In, Sd	In	Pr2
SdF	Set point for SMART DEFROST	-30 + +30°C / -22++86°F	0	Pr2
dIE	Defrost termination temperature	-50,0+110°C / -58+230°F	8	Pr1
ldF	Interval between defrost cycles	1+120ore	6	Pr1
MdF	(Maximum) length for 1° defrost	0+255 min.	30	Pr1
dFd	Displaying during defrost	rt, it, SET, dEF, dEG	it	Pr2
dAd	MAX display delay after defrost	0+255 min.	30	Pr2
Fdt	Draining time	0+60 min.	0	Pr2
dPO	First defrost after start up	n + y	n	Pr2
dAF	Defrost delay after fast freezing	0 + 23h 50 min.	2	Pr2
<b>FANS</b>				
FnC	Fans operating mode	C-n, C-y, O-n, O-y	O-n	Pr2
Fnd	Fans delay after defrost	0+255 min.	10	Pr2
FSt	Fans stop temperature	-50,0+110°C / -58+230°F	2	Pr2
<b>ALARMS</b>				
ALC	Temperature alarms configuration	re + Ab	rE	Pr2
ALU	MAXIMUM temperature alarm	-50,0+110°C / -58+230°F	10	Pr1
ALL	minimum temperature alarm	-50,0+110°C / -58+230°F	10	Pr1
AFH	Temperature alarm and fan differential	0,1+25,5 °C / 1+45°F	2	Pr2
ALd	Temperature alarm delay	0+255 min.	15	Pr2
dAO	Delay of temperature alarm at start up	0 + 23h 50 min.	1,3	Pr2
EdA	Alarm delay at the end of defrost	0+255 min.	30	Pr2
dot	Delay of temperature alarm after closing the door	0+255 min.	15	Pr2
dOA	Open door alarm delay	0+255 min.	15	Pr2
tBA	Alarm relay silencing	y + n	y	Pr2
nPS	Pressure switch activation number	0+15	0	Pr2
<b>ANALOGUE OUTPUT</b> 4+20mA (Optional)				
AOS	Analogue output start point	-50,0+110°C / -58+230°F	0/32	Pr2
APb	Analogue output band width	-50,0+110°C / -58+230°F	0	Pr2
CAO	Input type for the analogue output	P1+1r2	P1	Pr2
<b>ANALOGUE INPUTS</b>				
Ot	Thermostat probe calibration	-12,0+12,0°C / -21+21°F	0	Pr1
OE	Evaporator probe calibration	-12,0+12,0°C / -21+21°F	0	Pr2
O3	Auxiliary probe calibration	-12,0+12,0°C / -21+21°F	0	Pr2
P2P	Evaporator probe presence	n + y	y	Pr2
P3P	Auxiliary probe presence	n + y	n	Pr2
Pbr	Regulation probe selection	P1 + 1r2	P1	Pr2

HES	Temperature increase during the Energy Saving cycle	-30+30°C / -22+86°F	0	Pr2
<b>DIGITAL INPUTS</b>				
OdC	Open door control	no, Fan, CPr, F_C	Fan	Pr2
I1P	Door switch polarity	CL+OP	CL	Pr2
I2P	Configurable digital input polarity	CL+OP	CL	Pr2
I2F	Digital input configuration	EAL, bAL, PAL, dFr, AuS, ES, OnF	EAL	Pr2
dId	Digital input alarm delay	0+255 min.	5	Pr2
<b>TIME AND WEEKLY HOLIDAYS</b>				
Hur	Current hour	0 + 23	0	Pr2
Min	Current minute	0 + 59	0	Pr2
dAY	Current day	Sun + SAT	Sun	Pr2
Hd1	First weekly holiday	Sun + SAT - nu	nu	Pr2
Hd2	Second weekly holiday	Sun + SAT - nu	nu	Pr2
Hd3	Third weekly holiday	Sun + SAT - nu	nu	Pr2
<b>ENERGY SAVING TIMES</b>				
ILE	Energy Saving cycle start during workdays	0 + 23h 50 min.	0	Pr2
dLE	Energy Saving cycle length during workdays	0 + 24h 00 min.	0	Pr2
ISE	Energy Saving cycle start on holidays	0 + 23h 50 min.	0	Pr2
dSE	Energy Saving cycle length on holidays	0 + 24h 00 min.	0	Pr2
HES	Temperature increase during the Energy Saving cycle	-30+30°C / -54+54°F	0	Pr2
<b>DEFROST TIMES</b>				
Ld1	1 <sup>st</sup> workdays defrost start	0 + 23h 50 min. - nu	6.0	Pr2
Ld2	2 <sup>nd</sup> workdays defrost start	0 + 23h 50 min. - nu	13.0	Pr2
Ld3	3 <sup>rd</sup> workdays defrost start	0 + 23h 50 min. - nu	21.0	Pr2
Ld4	4 <sup>th</sup> workdays defrost start	0 + 23h 50 min. - nu	nu	Pr2
Ld5	5 <sup>th</sup> workdays defrost start	0 + 23h 50 min. - nu	nu	Pr2
Ld6	6 <sup>th</sup> workdays defrost start	0 + 23h 50 min. - nu	nu	Pr2
Ld7	7 <sup>th</sup> workdays defrost start	0 + 23h 50 min. - nu	nu	Pr2
Ld8	8 <sup>th</sup> workdays defrost start	0 + 23h 50 min. - nu	nu	Pr2
Sd1	1 <sup>st</sup> holiday defrost start	0 + 23h 50 min. - nu	6.0	Pr2
Sd2	2 <sup>nd</sup> holiday defrost start	0 + 23h 50 min. - nu	13.0	Pr2
Sd3	3 <sup>rd</sup> holiday defrost start	0 + 23h 50 min. - nu	21.0	Pr2
Sd4	4 <sup>th</sup> holiday defrost start	0 + 23h 50 min. - nu	nu	Pr2
Sd5	5 <sup>th</sup> holiday defrost start	0 + 23h 50 min. - nu	nu	Pr2
Sd6	6 <sup>th</sup> holiday defrost start	0 + 23h 50 min. - nu	nu	Pr2
Sd7	7 <sup>th</sup> holiday defrost start	0 + 23h 50 min. - nu	nu	Pr2
Sd8	8 <sup>th</sup> holiday defrost start	0 + 23h 50 min. - nu	nu	Pr2
<b>OTHER</b>				
oA3	Auxiliary output configuration	ALr + AuS	ALr	Pr2
Adr	Serial address	1+247	1	Pr1
PbC	Probe type selection	NTC + PTC	NTC	Pr2
OnF	On / Off function enabled	n + y	n	Pr2
rEL	Software release	---	2.0	Pr2
Ptb	Map code	---	---	Pr2
Prd	Probes display	Pb1+Pb3	---	Pr2
Pr2	Access parameter list	---	---	Pr2

Dixell s.r.l. Z.I. Via dell'Industria, 27  
32010 Pieve d'Alpago (BL) ITALY  
tel. +39- 0437 - 98 33 - fax +39- 0437 - 98 93 13  
E-mail: dixell@dixell.com - http://www.dixell.com